



SUN Small Floodlight



8840113

SUN Small Floodlight - 1 COB 3000K 26°

Lighting information

Source power type	1 COB
Colour temperature	3000K
CRI	>80
MCADAMS	3
LM 80/TM-21	L80B10@>60Kh

Source power	21,00 W
Nominal flux	2925 lm

Plug-in power	27,00 W
Real flux	1890 lm
Maximum intensity	3075 cd/klm
Beam angle	26°
Tilttable	

Power Supply Unit	220 ÷ 240V
Operating frequency	0/50/60 Hz
Power factor	0,95
Dimmable	DALI
Safety class	I
Luminaires of B16A MCB	Max 50
Inrush current	5A 50µsec
Wiring	Internal

Protection Rating	IP66
Breaking Strength	IK 09

Energy efficiency class	A/A+/A++
Diffuser type	Serigraphed extra-clear glass
Diffuser thickness	5 mm
Windage area	0.0400 m ²

Colours

Standard colour

● .06 Grey

Colours available on request

● .01 Black

○ .02 White

● .07 Corten

● .08 Anthracite

● .09 Bronze



Platek®

PLATEK s.r.l.
Via Paderno, 19 | 25050 Rodengo Saiano (BS) ITALY
P.IVA 03320290178 | Codice fiscale 03007130176
Registro delle Imprese di Brescia n. 03007130176 REA 311057
Capitale sociale Euro 1.000.000,00 i.v. Società con unico socio

Last update:15/02/2022



SUN Small Floodlight

8840113

SUN Small Floodlight - 1 COB 3000K 26°

Product features

Die-cast body and front locking trim manufactured in aluminium alloy EN 44300 with very low copper content. No visible cables. Central rotation joint on two axes with locking system with safety pin for secure positioning. A4 Stainless steel screws. Subjected to galvanic anodizing treatment divided into distinct phases: mechanical satin finishing, surface degreasing, anodic oxidation and final sealing. The product is painted following a continuous two step paint process (epoxy-based primer + polyester-based colour finish), which allows to generate a single thick protective coating which then generates a protective barrier against atmospheric agents and UV rays. Before fixing the diffuser on the Platek products a Pre-treatment using an atmospheric pressure plasma process is carried out on the surface. The process activates the ionic load on the surface exactly where it is needed, thus promoting the best silicone grip possible and removing any residual release of agents for a longer lasting seal. The next steps are the coating of silicone and the assembly of the diffuser on the lighting fixture, with an automated process to guarantee the perfect sealing of the lamp.

Technical dimensions

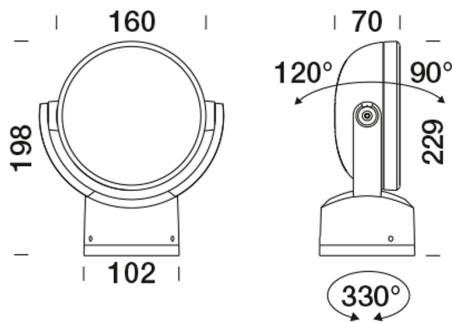

Technical shipping information

Net weight	2,10 kg
Gross weight	2,40 kg
Packaging width	350,00 mm
Packaging height	200,00 mm
Packaging depth	350,00 mm

Lighting information

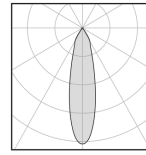

Plug-in power	27,00 W
Real flux	1890 lm
Maximum intensity	3075 cd/klm
Beam angle	26°

Lighting Simulation



Medium beam angle

simulation made with SUN Small Floodlight 27,0 W 3000K

Optics:	26°
Code:	8840113
Distance between products:	6 m
Wall height:	8 m

Plug-in power	27,00 W
Real flux	1890 lm
Maximum intensity	3075 cd/klm
Beam angle	26°

Platek®

PLATEK s.r.l.
 Via Paderno, 19 | 25050 Rodengo Saiano (BS) ITALY
 P.IVA 03320290178 | Codice fiscale 03007130176
 Registro delle Imprese di Brescia n. 03007130176 REA 311057
 Capitale sociale Euro 1.000.000,00 i.v. Società con unico socio



SUN Small Floodlight

8840113

SUN Small Floodlight - 1 COB 3000K 26°

Mechanical accessories

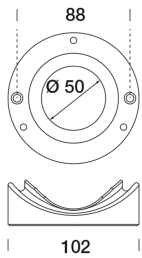

8951035
Fixing system for SUN floodlights on Ø 60/76/102 mm poles

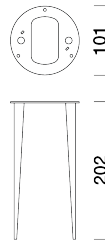

9005125
AISI 304 stainless steel spike

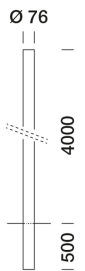

8624024
Pole h. 4 m above ground - Ø 76 mm designed for 4 floodlights with inspection door and terminal block

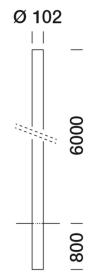

8624036
Pole h. 6 m above ground - Ø 102 mm designed for 6 floodlights with inspection door and terminal block

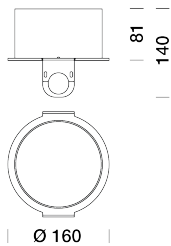

8935601
Cylindrical screen

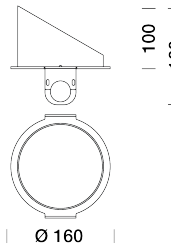

8935611
Visor

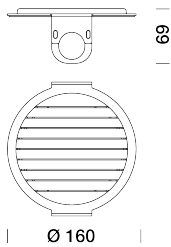

8905321
Anti-glare grid

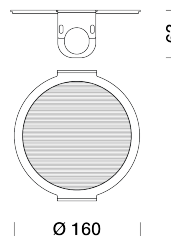

8918221
Elliptical glass



SUN Small Floodlight

8840113

SUN Small Floodlight - 1 COB 3000K 26°

The process of galvanisation and multi-coating protection

Platek goes well beyond the standards required for conventional protection processes, making use of its longstanding and in-depth expertise in aluminium alloys. All the aluminium components of the products - extruded, die-cast or turned - are subjected to a galvanic anodizing process in the phase following mechanical processing. The process increases their wear resistance and improves the adhesion of the paint. Galvanization involves three distinct phases: mechanical satin finishing and surface degreasing, anodic oxidation and fixing. After the first phase that eliminates any impurities, the aluminium body is immersed in special electrolytic tanks, in which the aluminium surface is transformed into aluminium oxide, which makes the metal more resistant. To respond optimally to the needs of the global market, all Platek products undergo a two-layer painting process. After preparation with washing and rinsing in accordance with the strictest environmental standards, the product is coated with an epoxy primer which guarantees, in addition to anodizing, an excellent degree of protection. The final step is the preparation of the polyester powder which gives the final velvety finish of the component. These last two phases, being done in a continuous cycle, form a single high-thickness layer that is resistant to the action of UV rays and atmospheric agents. This process allows corrosion resistance in salt fog that far exceeds the average standards of the market to be achieved.

The gluing process and plasma treatment

One of the most complex and delicate aspects in outdoor lighting products is the fitting of glass onto the lighting body. This must ensure over time an excellent degree of insulation from atmospheric agents, even in harsh environmental conditions, to maintain a stable performance with zero maintenance. The gluing process of the glass on Platek products is managed at an automated workstation, preceded by a pre-treatment of the surfaces with atmospheric pressure plasma. Pre-treatment modifies the characteristics and ionic properties of the treated surfaces, activates the polar materials at strategic points, removes any residue of detaching agents, such as silicones and oils with a precision microcleaning, favouring excellent wettability of the bonded surfaces and a stable seal in time. The gluing process of the glass with specific plasma treatment allows a bonding force four times greater than similar products to be obtained. The shaping of the surfaces is followed by the application of the silicone and the assembly of the glass onto the lighting body using an automated process that guarantees perfect sealing of the lamp.

Precise LED selection

All LEDs used by Platek, once assembled by trusted personnel are tested with suitable instruments to check the colour specification required by Platek standards. The choice of using only 3 McAdams colour steps and with a CRI value exceeding 90, provide a high level of light quality that is difficult to find in the world of outdoor lighting. As far as LED products are concerned, Platek has adopted a system of protection against electrostatic discharge along the entire production chain of electronic components to increase the resistance of circuits to power surges.

Platek®

PLATEK s.r.l.
Via Paderno, 19 | 25050 Rodengo Saiano (BS) ITALY
P.IVA 03320290178 | Codice fiscale 03007130176
Registro delle Imprese di Brescia n. 03007130176 REA 311057
Capitale sociale Euro 1.000.000,00 i.v. Società con unico socio

Last update:15/02/2022