

CHIODINO



9402314

CHIODINO Bollard h. 1600 mm - 1 LED 3000K diffuse

Lighting information

Source power type	1 LED
Colour temperature	3000K
CRI	>90
MCADAMS	3

Source power	9,00 W
Nominal flux	640 lm

Real flux	470 lm
Maximum intensity	412 cd/klm
Beam angle	diffuse

Power Supply Unit	24V
Operating frequency	DC
Dimmable	PWM
Safety class	III
Wiring	External
Cable section	2 x 0,50 mm ²
Cable length	3.400 mm;
Cable type	NS20 rubber
Connector	To be ordered separately

Protection Rating	IP65
Breaking Strength	IK 07

Energy efficiency class	A/A+/A++
Diffuser type	
Diffuser thickness	10 mm

Colours

Standard colour

- .01 Black
- .07 Corten

Colours available on request

- .02 White
- .04 Green Forest
- .05 Rose Ballerina
- .06 Grey
- .08 Anthracite

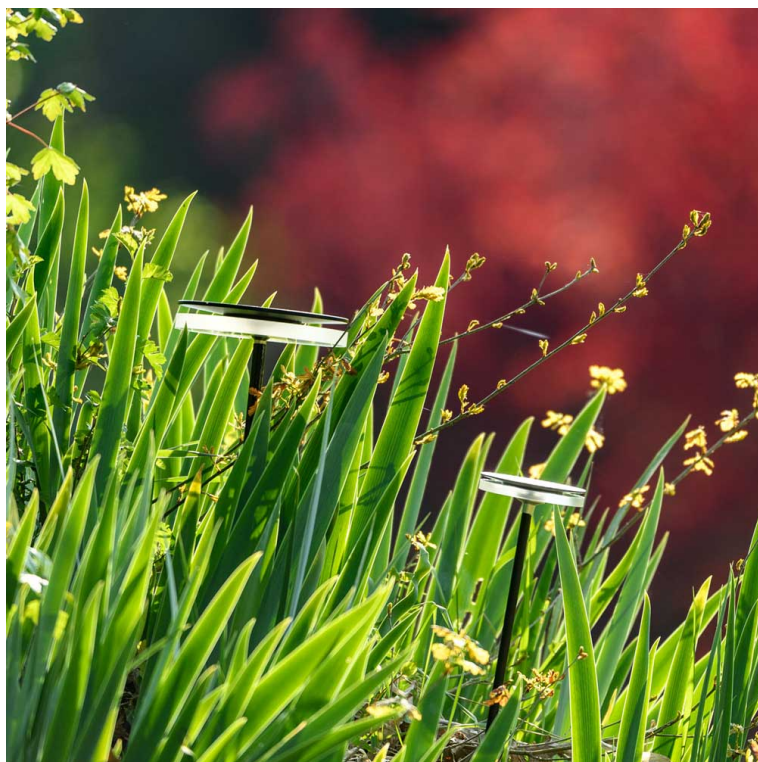

Platek®

PLATEK s.r.l.
Via Paderno, 19 | 25050 Rodengo Saiano (BS) ITALY
P.IVA 03320290178 | Codice fiscale 03007130176
Registro delle Imprese di Brescia n. 03007130176 REA 311057
Capitale sociale Euro 1.000.000,00 i.v. Società con unico socio

Last update:22/03/2022

CHIODINO

9402314

CHIODINO Bollard h. 1600 mm - 1 LED 3000K diffuse

Product features

Aluminium rod and head, the product is painted following a continuous two step paint process (epoxy-based primer + polyester-based colour finish), which allows to generate a single thick protective coating which then generates a protective barrier against atmospheric agents and UV rays. Spike or ground fixing base in AISI 316 stainless steel. PMMA opal diffuser screen. No visible screws.

Lighting information

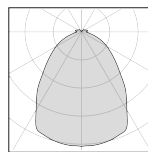

Real flux	470 lm
Maximum intensity	412 cd/klm
Beam angle	diffuse

Real flux	470 lm
Maximum intensity	412 cd/klm
Beam angle	diffuse

Technical dimensions

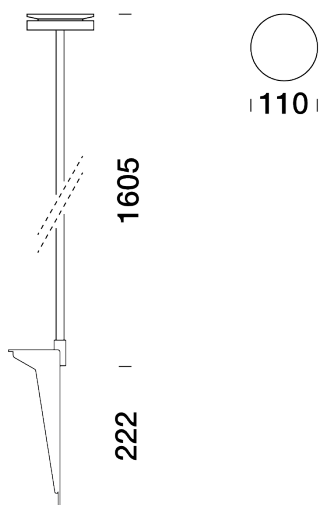

Technical shipping information

Net weight	0,33 kg
Gross weight	0,47 kg
Packaging width	1.895,00 mm
Packaging height	210,00 mm
Packaging depth	120,00 mm

Platek®

PLATEK s.r.l.
Via Paderno, 19 | 25050 Rodengo Saiano (BS) ITALY
P.IVA 03320290178 | Codice fiscale 03007130176
Registro delle Imprese di Brescia n. 03007130176 REA 311057
Capitale sociale Euro 1.000.000,00 i.v. Società con unico socio

Last update:22/03/2022

Electrical accessories

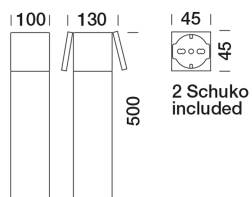

8910502
Service post H 500 mm (.08 anthracite)

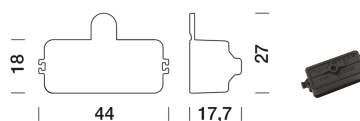

8917006
IP68 connector for 2x0,75 mm² cable

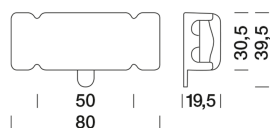

8917012
IP68 connector for 4x1,5 mm² cable

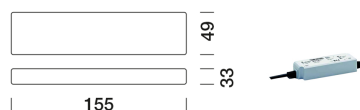

8956127
IP67 Power supply (24V DC - 75W)

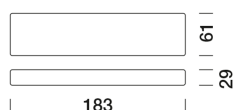

8956307
IP20 Power supply (24V DC - 75W)

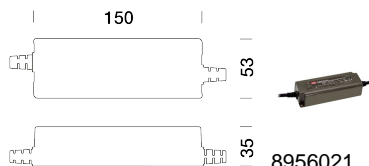

8956021
Power supply DALI (24V DC - 60W) IP67



CHIODINO

9402314

CHIODINO Bollard h. 1600 mm - 1 LED 3000K diffuse

Platek®

PLATEK s.r.l.
Via Paderno, 19 | 25050 Rodengo Saiano (BS) ITALY
P.IVA 03320290178 | Codice fiscale 03007130176
Registro delle Imprese di Brescia n. 03007130176 REA 311057
Capitale sociale Euro 1.000.000,00 i.v. Società con unico socio

Last update:22/03/2022