

High Bay Round IP65 Gen2 Honey Comb



DATA SHEET



Product information

The IP65 Round High Bay with HoneyComb® optic is designed to replace traditional high ceiling fixture applications. The HoneyComb® optic together with the specially designed housing frame provides an, dual anti-glare and more comfortable UGR level in all industrial areas (RG0). The lower glare means a more comfortable light for your working environment while the efficacy is above 135lm/W which provides additional savings. The robust design offers a long lifetime solution for all applications.

Benefits

- Designed for replacement of conventional high bays with HID lamps up to 400W
- High luminous efficiency and energy savings up to 70% compared to conventional high bay fixtures
- An affordable solution for retrofit or new installations
- Different accessories for available for versatile installation: suspension chain or metal bracket

Features

- 60°, 70°, 80° beam angle HoneyComb® optic
- Low glare rate, <UGR22 up to 150W
- IP65 protection rating
- IK08 rating
- Class I
- Voltage 220-240V
- Lifespan 80k hours at 25°C (L70/B50)
- 4000K & 5000K CCT
- PF >0.95
- CRI >80
- Ambient temperature: -30°C ~ 50°C
- Lumileds LED chip
- Static, 1-10V and DALI control
- Motion sensor versions could be controlled by remote controller up to 15m installation height.
- Suspended (chain) and surface mounted (bracket) options

Application areas



Industrial/
Warehouse



Retail

Fixture structure

Die-cast aluminium housing with tempered glass diffuser and 60/70/80° honeycomb structured aluminium reflectors

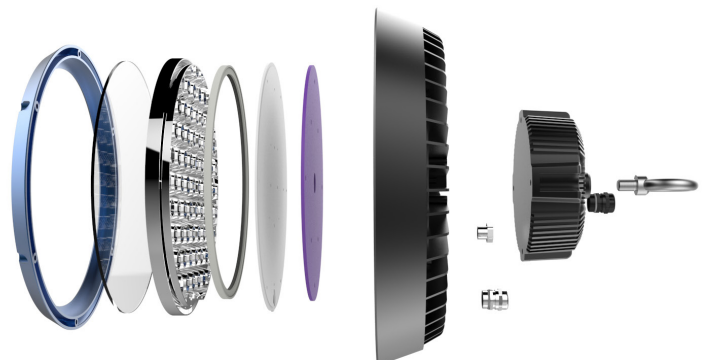

Specification summary

Product code	Description	Lumen (lm)	Wattage (W)	Efficacy (lm/W)	Beam angle	CCT (K)	CRI	UGR **	Energy Class	Control	IP rating	PF
93114909	High Bay TU Gen2 90W-4000K-2D-70°	12150	90	135	70°	4000K	>80	22.5	A++	DALI	IP65	>0.95
93114913	High Bay TU Gen2 90W-5000K-2D-70°	12150	90	135	70°	5000K	>80	22.5	A++	DALI	IP65	>0.95
93114907	High Bay TU Gen2 100W-4000K-2A-70°	13500	100	135	70°	4000K	>80	23.5	A++	1-10V	IP65	>0.95
93114911	High Bay TU Gen2 100W-5000K-2A-70°	13500	100	135	70°	5000K	>80	23.5	A++	1-10V	IP65	>0.95
93114908	High Bay TU Gen2 100W-4000K-2M-70°	13500	100	135	70°	4000K	>80	22.7	A++	Sensor	IP65	>0.95
93114912	High Bay TU Gen2 100W-5000K-2M-70°	13500	100	135	70°	5000K	>80	23.1	A++	Sensor	IP65	>0.95
93114906	High Bay TU Gen2 100W-4000K-2S-70°	13500	100	135	70°	4000K	>80	23.2	A++	Static	IP65	>0.95
93114910	High Bay TU Gen2 100W-5000K-2S-70°	13500	100	135	70°	5000K	>80	23	A++	Static	IP65	>0.95
93114917	High Bay TU Gen2 140W-4000K-2A-60°	18900	140	135	60°	4000K	>80	21	A++	1-10V	IP65	>0.95
93114925	High Bay TU Gen2 140W-5000K-2A-60°	18900	140	135	60°	5000K	>80	21	A++	1-10V	IP65	>0.95
93114916	High Bay TU Gen2 140W-4000K-2A-80°	18900	140	135	80°	4000K	>80	25.2	A++	1-10V	IP65	>0.95
93114924	High Bay TU Gen2 140W-5000K-2A-80°	18900	140	135	80°	5000K	>80	25.2	A++	1-10V	IP65	>0.95
93114919	High Bay TU Gen2 140W-4000K-2M-60°	18900	140	135	60°	4000K	>80	21	A++	Sensor	IP65	>0.95
93114927	High Bay TU Gen2 140W-5000K-2M-60°	18900	140	135	60°	5000K	>80	21	A++	Sensor	IP65	>0.95
93114918	High Bay TU Gen2 140W-4000K-2M-80°	18900	140	135	80°	4000K	>80	24.7	A++	Sensor	IP65	>0.95
93114926	High Bay TU Gen2 140W-5000K-2M-80°	18900	140	135	80°	5000K	>80	24.7	A++	Sensor	IP65	>0.95
93114915	High Bay TU Gen2 140W-4000K-2S-60°	18900	140	135	60°	4000K	>80	21	A++	Static	IP65	>0.95
93114923	High Bay TU Gen2 140W-5000K-2S-60°	18900	140	135	60°	5000K	>80	21	A++	Static	IP65	>0.95
93114914	High Bay TU Gen2 140W-4000K-2S-80°	18900	140	135	80°	4000K	>80	25.2	A++	Static	IP65	>0.95
93114922	High Bay TU Gen2 140W-5000K-2S-80°	18900	140	135	80°	5000K	>80	24.8	A++	Static	IP65	>0.95
93114921	High Bay TU Gen2 150W-4000K-2D-60°	19500	150	130	60°	4000K	>80	21.1	A++	DALI	IP65	>0.95
93114929	High Bay TU Gen2 150W-5000K-2D-60°	19500	150	130	60°	5000K	>80	21.1	A++	DALI	IP65	>0.95
93114920	High Bay TU Gen2 150W-4000K-2D-80°	19500	150	130	80°	4000K	>80	25.2	A++	DALI	IP65	>0.95
93114928	High Bay TU Gen2 150W-5000K-2D-80°	19500	150	130	80°	5000K	>80	25.2	A++	DALI	IP65	>0.95
93114933	High Bay TU Gen2 190W-4000K-2A-60°	24700	190	130	60°	4000K	>80	22.1	A++	1-10V	IP65	>0.95
93114941	High Bay TU Gen2 190W-5000K-2A-60°	24700	190	130	60°	5000K	>80	22.1	A++	1-10V	IP65	>0.95
93114932	High Bay TU Gen2 190W-4000K-2A-80°	24700	190	130	80°	4000K	>80	26	A++	1-10V	IP65	>0.95
93114940	High Bay TU Gen2 190W-5000K-2A-80°	24700	190	130	80°	5000K	>80	26	A++	1-10V	IP65	>0.95
93114935	High Bay TU Gen2 190W-4000K-2M-60°	24700	190	130	60°	4000K	>80	22.1	A++	Sensor	IP65	>0.95
93114943	High Bay TU Gen2 190W-5000K-2M-60°	24700	190	130	60°	5000K	>80	22.1	A++	Sensor	IP65	>0.95
93114934	High Bay TU Gen2 190W-4000K-2M-80°	24700	190	130	80°	4000K	>80	26	A++	Sensor	IP65	>0.95
93114942	High Bay TU Gen2 190W-5000K-2M-80°	24700	190	130	80°	5000K	>80	26	A++	Sensor	IP65	>0.95
93114931	High Bay TU Gen2 190W-4000K-2S-60°	24700	190	130	60°	4000K	>80	22.1	A++	Static	IP65	>0.95
93114939	High Bay TU Gen2 190W-5000K-2S-60°	24700	190	130	60°	5000K	>80	22.1	A++	Static	IP65	>0.95
93114930	High Bay TU Gen2 190W-4000K-2S-80°	24700	190	130	80°	4000K	>80	25.6	A++	Static	IP65	>0.95
93114938	High Bay TU Gen2 190W-5000K-2S-80°	24700	190	130	80°	5000K	>80	25.6	A++	Static	IP65	>0.95
93114937	High Bay TU Gen2 230W-4000K-2D-60°	28750	230	125	60°	4000K	>80	22.6	A++	DALI	IP65	>0.95
93114945	High Bay TU Gen2 230W-5000K-2D-60°	28750	230	125	60°	5000K	>80	22.6	A++	DALI	IP65	>0.95
93114936	High Bay TU Gen2 230W-4000K-2D-80°	28750	230	125	80°	4000K	>80	25.8	A++	DALI	IP65	>0.95
93114944	High Bay TU Gen2 230W-5000K-2D-80°	28750	230	125	80°	5000K	>80	25.8	A++	DALI	IP65	>0.95

Adjustable accessories*

93115197	High Bay TU Gen2 Bracket for 280
93115198	High Bay TU Gen2 Bracket for 360
93116529	High Bay TU Gen2 Remote control

*accessories to be ordered separately

** UGR value refers to a room with dimensions of 4H/8H and degrees of reflectance of 20% for the floor, 50% for the walls and 70% for the ceiling.

Dimensions (mm)

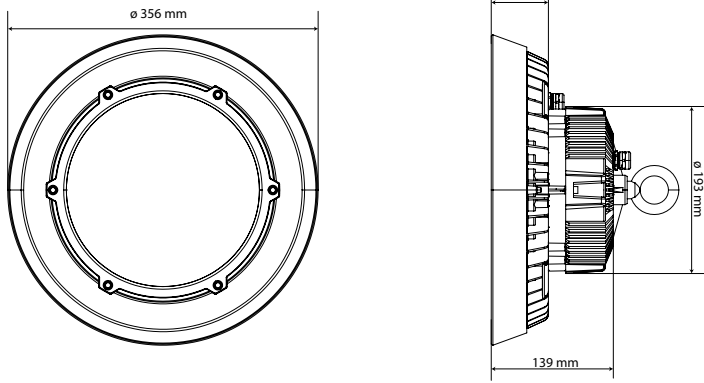

Model	Wattage	Fixture diameter (mm)	Fixture height incl driver and hook (mm)	Weight incl driver (kg)	Driver size (mm)	Control
High Bay TU Gen2 90Wxxx	90W	280	190	2.66	Ø132*71	DALI
High Bay TU Gen2 100Wxxx	100W	280	190	2.66	Ø132*71	static/1-10V/Sensor
High Bay TU Gen2 140Wxxx	140W	360	210	3.08	Ø151*71	static/1-10V/Sensor
High Bay TU Gen2 150Wxxx	150W	360	210	3.08	Ø151*71	DALI
High Bay TU Gen2 190Wxxx	200W	360	210	5.50	Ø182*71	static/1-10V/Sensor
High Bay TU Gen2 200Wxxx	230W	360	210	5.50	Ø182*71	DALI



Ordering information

Internal Code	Generation	System Wattage	CCT	Voltage	Controller	Beam angle	Shipment
High Bay TU	Gen2	90W	4000K 5000K	2 - 220-240V	S - Static A - 1-10V Dimmable M - Motion sensor D - Dali	60° 70° 80°	DS - Direct Shipment
		100W					
		140W					
		150W					
		190W					
		230W					

Example: High Bay TU Gen2 190W-4000K-2S-60°
190W 4000K High bay with 60° beam angle HoneyComb optic and static driver

Photometric data

Static version

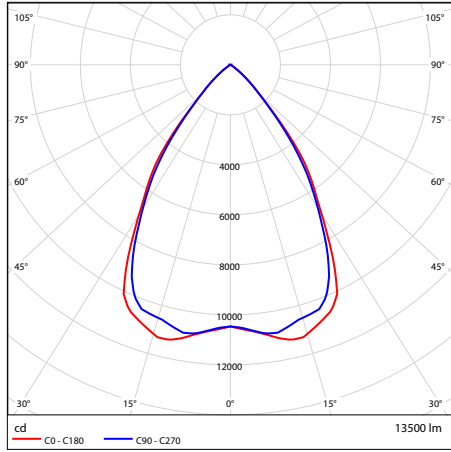

100W

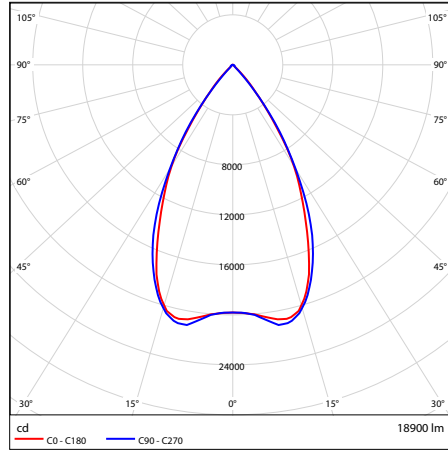

140W

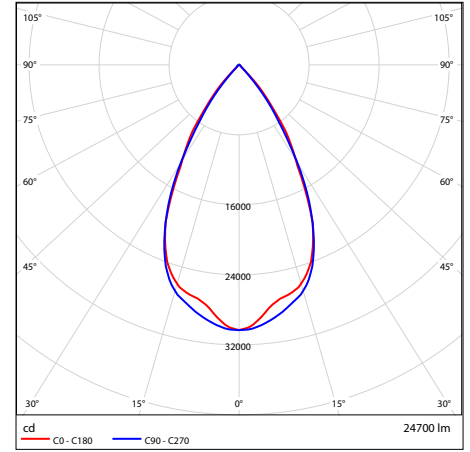

190W

DALI version

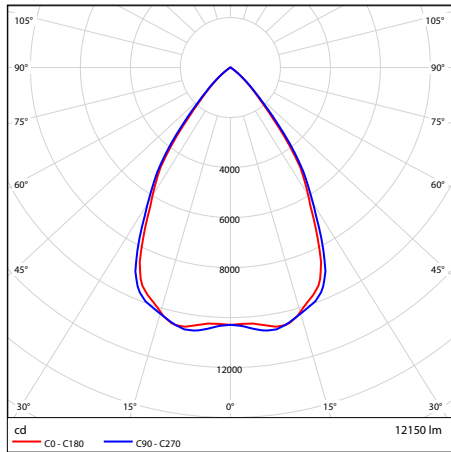

90W

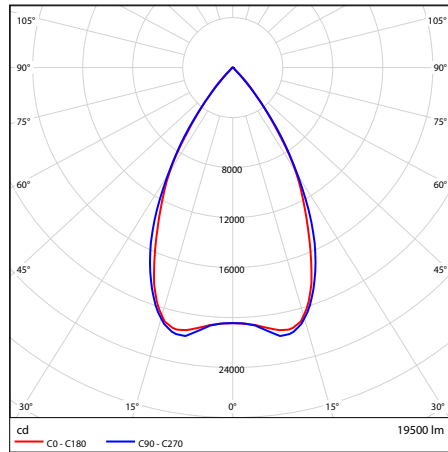

150W

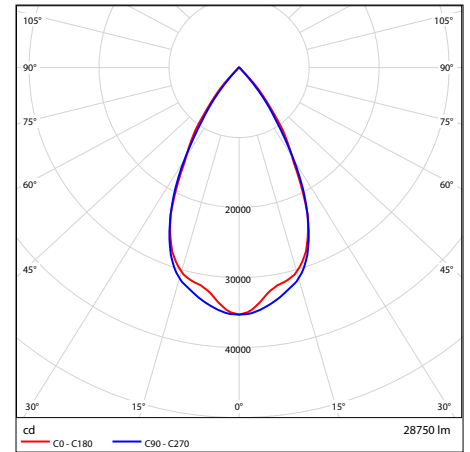

230W

Photometry is based on LM79

Regulatory and standards

Regulatory mark: CE

Regulations: 2014/35/EU, 2014/30/EU, 2011/65/EU, (framework 2009/125/EC) EU/1194/2012 amended by EU 2015/1428, (framework 2010/30/EC) 874/2012 and 518/2014*, 2012/19/EU*

Harmonised standards: EN 60598, EN 62493, EN 61547, EN55015, EN 61000, refer to CE Declaration of Conformity and Technical File for details

Photobiological risk assessment group 0. The product is considered safe, does not pose any photobiological hazard

*not on DOC